

Requirements

- Wired or Wireless Internet Connection
- A Wired or Wireless Network Device (Tablet, Smartphone, Mac or Windows Computer)
- Power Outlet
- Ethernet cable (optional, dependent on mode)

Package Contents

- 1x Wireless-300N Multi-Function Extender Pro
- 1x Power Adapter 5V/2A
- 1x Ceiling/Wall Mounting Bracket
- 1x Pack of Mounting Screws
- 1x Setup CD-ROM
- 1x Quick Installation Guide (QIG)

Start Here ▾ ▾

1 Hardware Setup

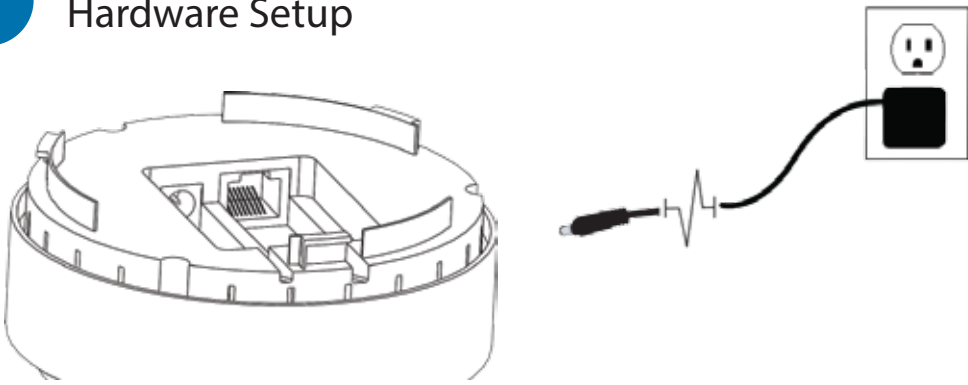

Twist base to remove the mounting bracket. Plug either the included A/C Adapter into the port labeled 5V/2A or, if using PoE, plug a ethernet cable into the LAN/PoE port if you have a PoE power source.

⚠ This Quick Installation Guide provides a quick and easy way to set up the HWABN25 in Universal Repeater or Access Point Modes. If you need to use the other modes, please refer to the manual located on the CD.

Top Panel Description

- Power LED**
Indicator that the power is switched on and correctly powered.
- Wireless LED**
LED is on when Wireless is activated. Blinking when wireless data is transmitting/receiving.
- Wired Connection LED**
LED is on when connected (When a ethernet cable is plugged into the ethernet port). Blinking when wired data is transmitting/receiving.
- WPS/Reset Button**
-WPS: Press and release to initiate WPS
-Reset to manufacturer settings: Press and hold down button for 15 seconds. Unplug the power for a few seconds then plug it back in for factory reset

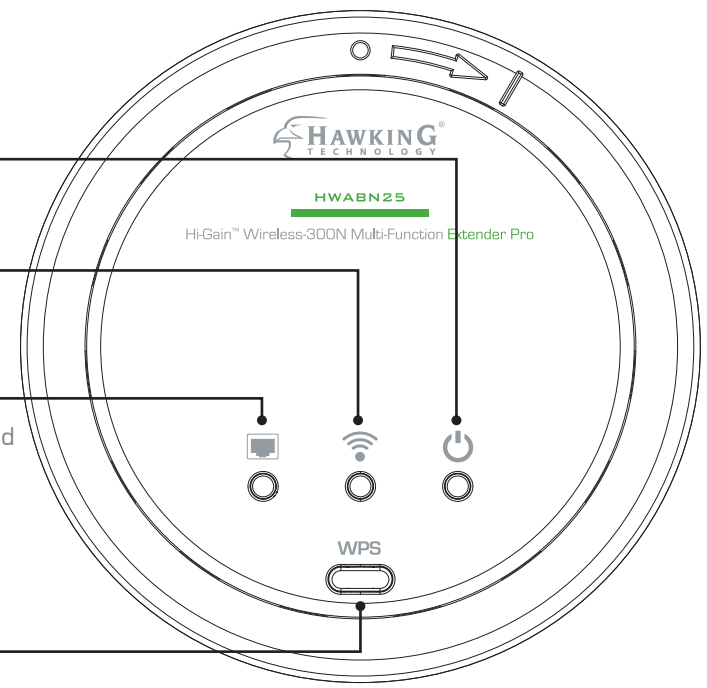

Bottom Panel Description

- Ethernet/Power over Ethernet (PoE)***
Local Area Network (LAN) port. Can also function as a PoE port if you have a PoE power supply. [* sold separately]
- Power Plug (5V/2A)**
Plug the provided A/C adapter to power on the device. (Not used if using PoE.)

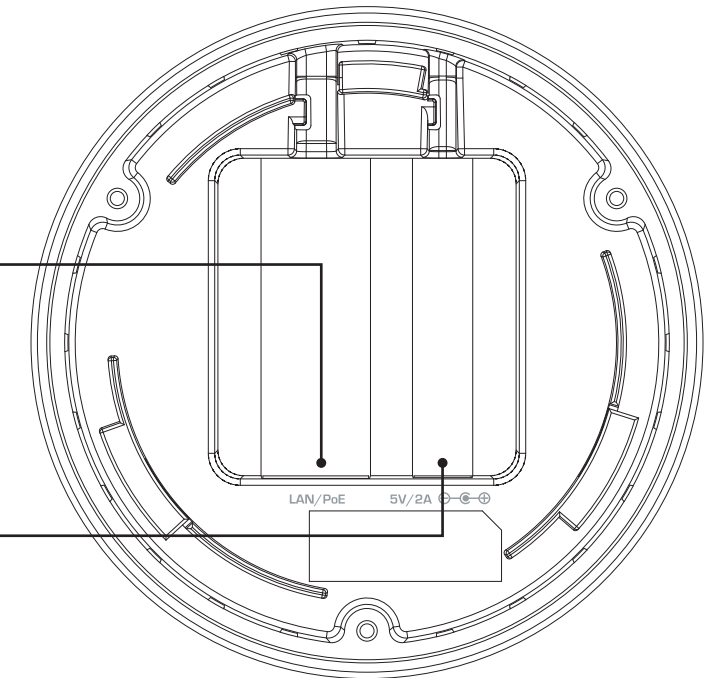

2 Configuring the HWABN25

Using WiFi enabled device, access the HWABN25 setup page by searching for the [Hawking_HWABN25](#). (If you are planning to configure the HWABN25 using a wired connection, please plug your computer into the port labeled "LAN", then go straight to Step 3.)

For Mac Users

Click on the Wi-Fi icon in the "Apple" toolbar. Click on the "**Hawking_HWABN25**" network from the drop-down menu. Then Continue to Step 3.



For Windows Users

On the lower right corner, go to your wireless network select. Click on "**Hawking_HWABN25**". Then Continue on to Step 3.



Using an iPad® or an iPhone®

Go to your wireless setting, select "**Hawking_HWABN25**" Network. Then, go to Step 3.

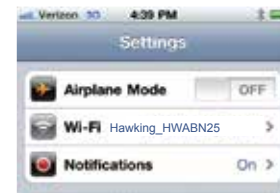

Make sure JavaScript is ON. To check your settings, go to Settings > Select Safari > then scroll down to view Javascript.



Using an Android device

On your mobile device, locate the "settings" menu.



Select "Wireless & Networks".

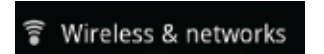

Click "Turn on Wi-Fi" and then click on the "Wi-Fi Settings" option.

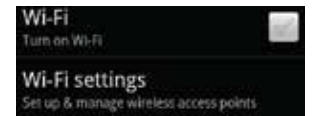

Look for "**Hawking_HWABN25**". Select it to connect. Then Continue to Step 3.

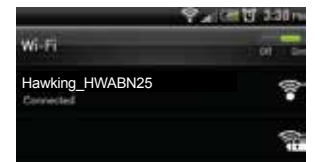

3 Login into the HWABN25

Using the same device, open a web browser and type in the following web address in the web address bar: <http://192.168.1.241>

Once the page loads, enter the following login information:

Login: **admin**
Password: **1234**
Click **Login** to continue

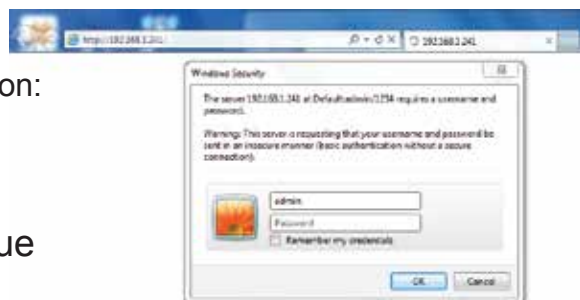

If the page doesn't load, please check if JavaScript is enabled. Generally, this should be enabled by default. However, if it's not, please go into your Browser Settings and enable JavaScript.

4 Choosing your Mode

In the drop down box, please select your mode of operation for the HWABN25. This quick installation guide will only outline the Universal Repeater and Access Point modes. For other modes and features, please refer to the manual on your CD.



5 Configuring the Universal Repeater (Range Extender) Mode or Access Point Mode

(For other modes, please refer to the User's Manual on the CD).

UNIVERSAL REPEATER MODE (also known as Range Extender Mode)

In this mode, the HWABN25 will repeat the wireless signal of an existing wireless router/access point. It will act as a wireless relay and create a larger seamless wireless network for your devices to connect to.

A. In the drop down menu, choose "Universal Repeater"



B. Click 'Scan' to find your wireless Internet connection. Select a network you would like to extend and click 'Connect'.

If the signal strength is low or your network does not appear, you may need to adjust the location of your HWABN25. Click 'Scan' to try again.

Select	SSID	Band	Chan	Encryption	Sign
<input type="radio"/>	HawkTech	(B+G+N)	3	WPA2-PSK	91
<input type="radio"/>	HawkTechC	(B+G+N)	3	WPA2-PSK	80

C. If the network you are connecting to is encrypted, the Quick Setup will prompt you to enter a security key. Enter the key and click 'Continue'. If there is **no security on the original network**, this step will automatically be skipped.

If you do not know the security key of the network you are connecting to, please consult your network administrator.

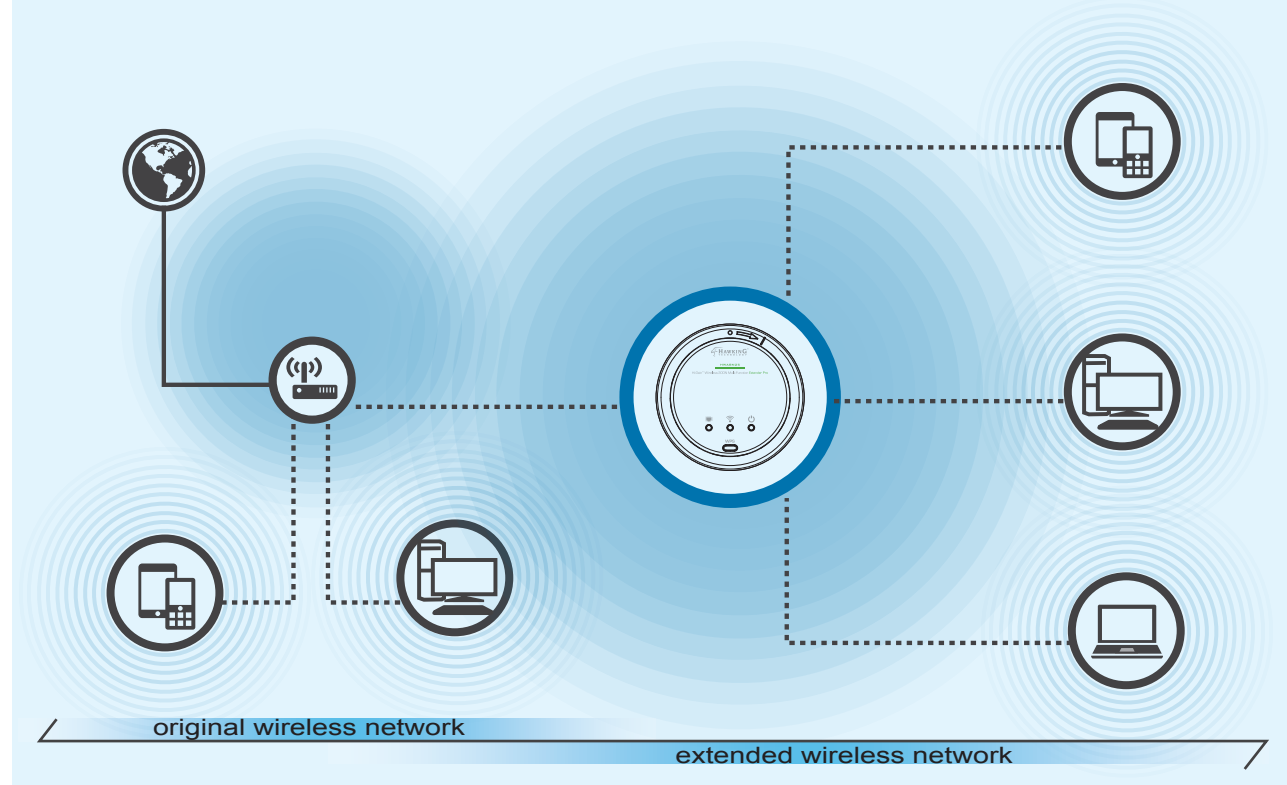

D. The setup of your HWABN25 is now complete. Click 'Apply' to complete your setup. The HWABN25 will automatically reboot and start repeating and extending your wireless network.

! After the reboot, the HWABN25 will join the original network. It will automatically be renamed to your original wireless network, unless otherwise specified during the set up process. **If you wish to modify this name, please refer to the user's manual.**

Make sure the HWABN25 is placed in a location where it can receive a strong signal from your desired wireless Internet connection. The Repeater Mode will not work without a signal it can repeat.

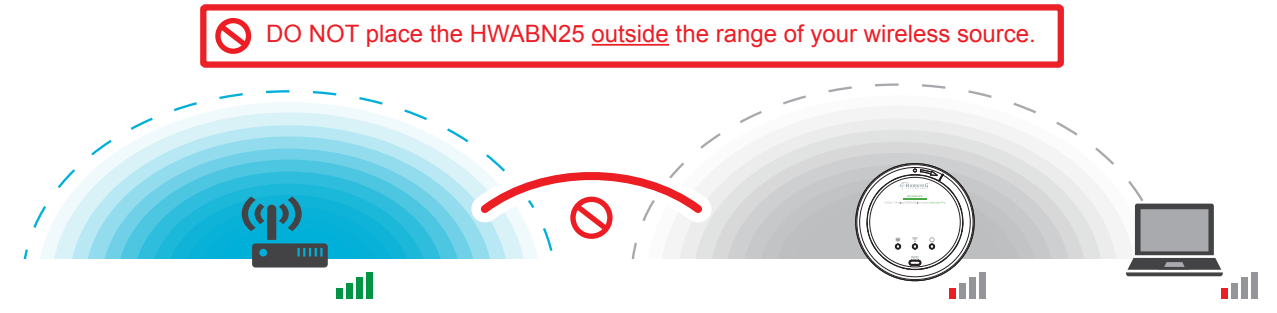
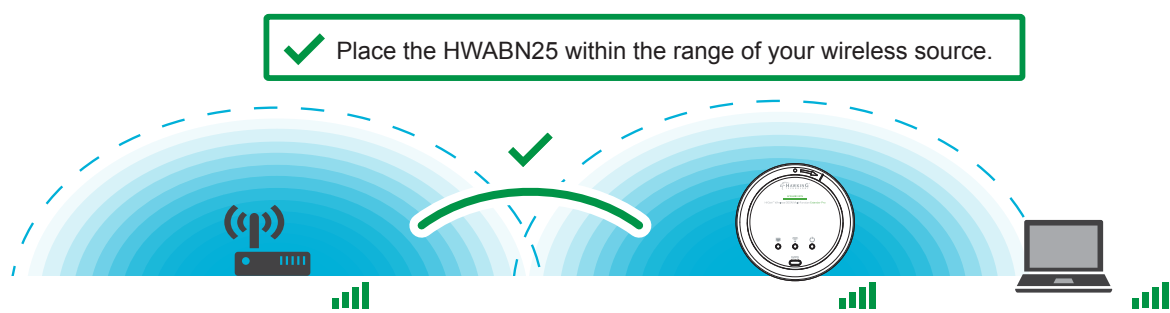

ACCESS POINT MODE

In the Access Point Mode, the HWABN25 broadcasts Wi-Fi Signal from a wired Network (e.g. a wired router) and allows your Wi-Fi enabled devices to connect wirelessly to your Network. Note: The HWABN25 must be plugged into the router or network after setup.

A. In the drop down menu, choose "AP" (Access Point).



The Main ESSID will be the wireless name of your network:

Default: **Hawking_HWABN25**

Click "Next".

If you wish to modify this name, please refer to the user's manual.

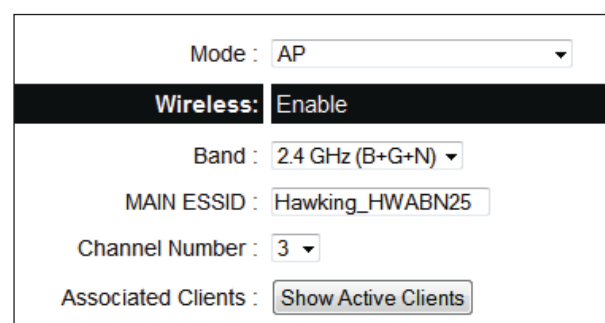

B. Hawking recommends you choose a security setting to protect your network from unauthorized users.

In the drop down box, please select "WPA (pre-shared key)". In the pre-shared key field, please create a password, at least 8 characters. If you wish to not use security or use a different type of security you can choose your selection from the drop down menu. Then, click "Apply".

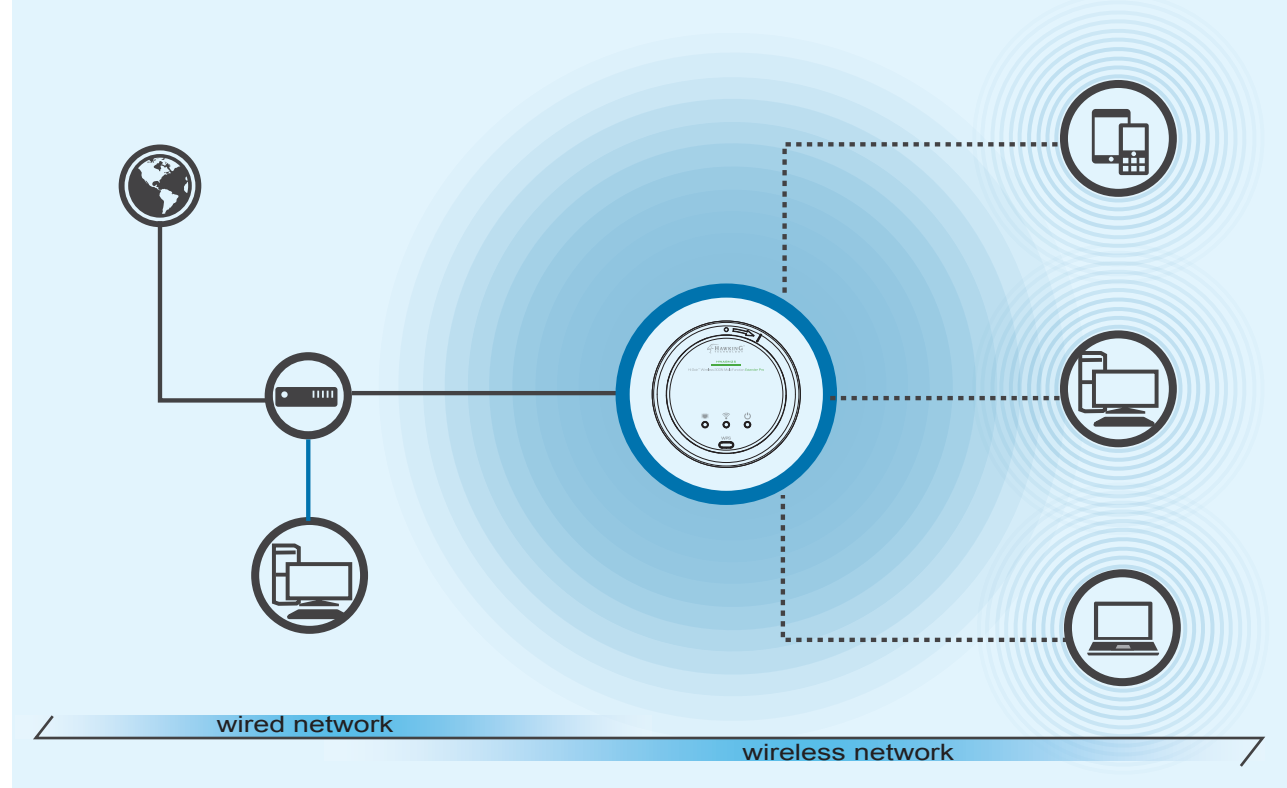
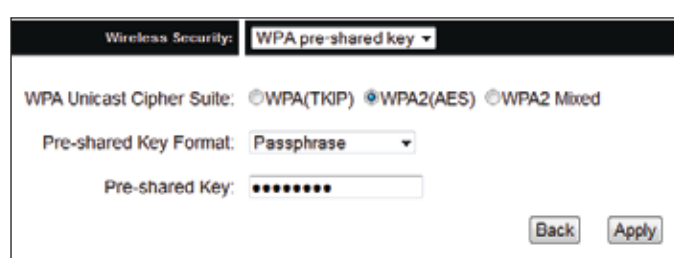

C. The HWABN25 will ask you if you wish to apply these settings. Click "Apply".

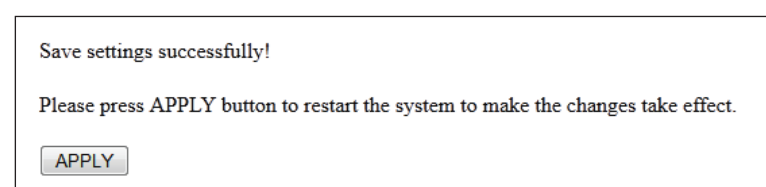

Congratulations! You have set up the HWABN25 as an Access Point. Please connect the HWABN25 into your network with an Ethernet cable in order for the HWABN25 to function properly in Access Point Mode.